

230-240V / 50-60Hz
IP40



WARNING - THIS LUMINAIRE MUST BE EARTHED

This luminaire has been tested and is manufactured to comply with BS EN 60598 : specification for general requirements and tests. It should be installed by a suitably qualified person in accordance with IEE.

CAUTION: there is a potential risk of electric shock from the LED boards when the product is operational with the cover removed.

NOTE: INSTALLATION AND OPERATION OF THE LUMINAIRE BEYOND ITS SCOPE OF SUPPLY WILL INVALIDATE THE WARRANTY.

DIL-0373-0001

1.

Standard Fitting

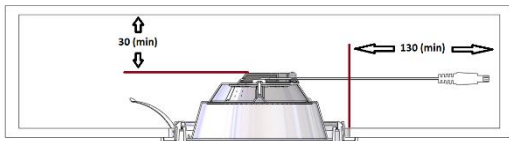

Emergency Fitting – due to emergency gear box

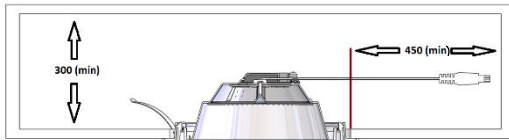

2.

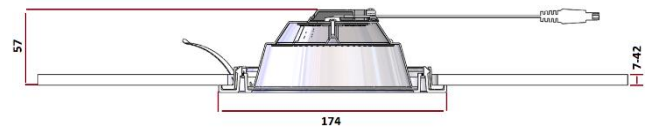

Cut-out 160mm

3.

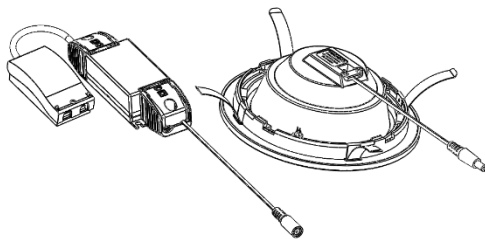

4.

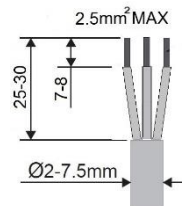
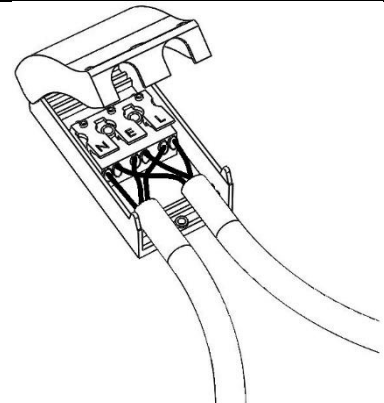
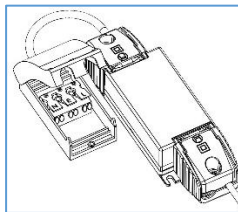

220-240V ~ 50/60Hz

5.

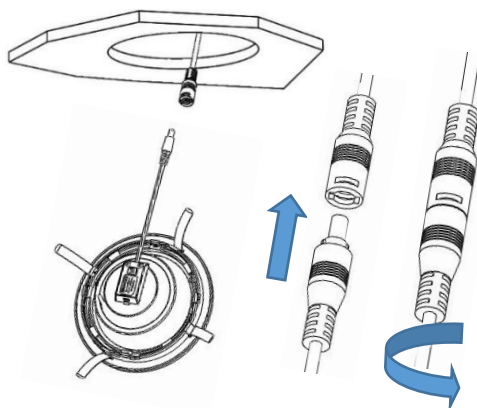

6.

