

230-240V / 50-60Hz

IP30

IK0

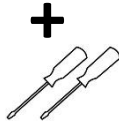

**WARNING - THIS LUMINAIRE MUST BE EARTHED**

This luminaire has been tested and is manufactured to comply with BS EN 60598 : specification for general requirements and tests. It should be installed by a suitably qualified person in accordance with IEE.

**CAUTION:** there is a potential risk of electric shock from the LED boards when the product is operational with the cover removed.

**NOTE:** INSTALLATION AND OPERATION OF THE LUMINAIRE BEYOND ITS SCOPE OF SUPPLY WILL INVALIDATE THE WARRANTY.

DIL-0322-0001

1.

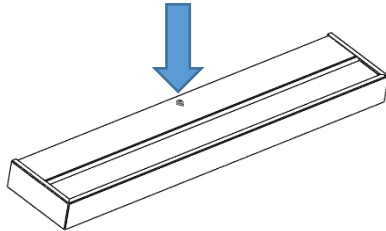

Fitting will be supplied complete. You will need to remove the wall mount bracket from the back of fitting in order to mount it to the wall. Remove the screw on the back edge of the fitting. This will release the wall mount bracket.

2.

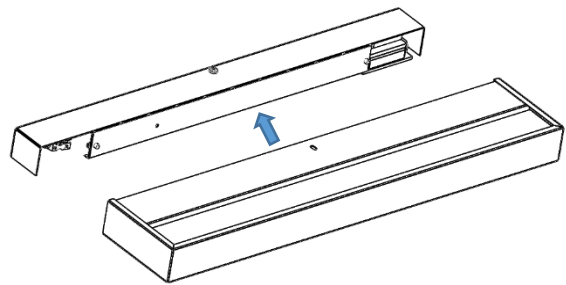

Slide the wall mount bracket out from the back of the fitting.

3.

Screw the wall mount bracket to the wall using the fixing points located between the bumper feet.

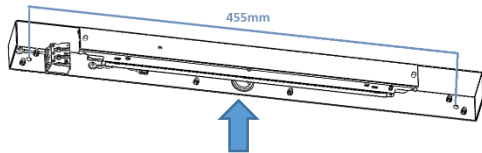

Then feed cable through the central hole and make the electrical connection to the terminal block.

4.

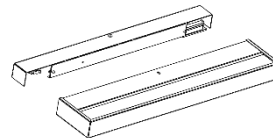

Offer the fitting back up to the wall mount bracket.

Connect the mount bracket to the fitting with the plug and socket, then earth cable to the brass tag.

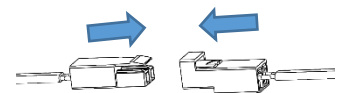

5.

Once connections have been made, slide the fitting onto the wall mount bracket. Refer to step 6 for sensor version  
Refer to step 7 for emergency version.

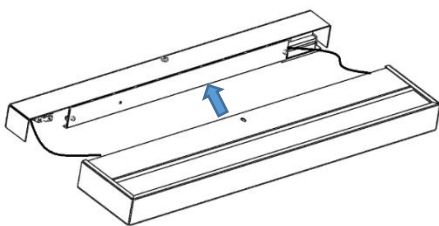

6.

**Sensor Version (Planum 500)** – ensure sensor plug and socket cable is positioned in the channel between the driver and back of the bracket before sliding fully onto bracket.

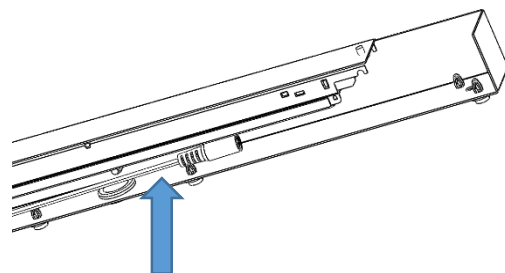

## Planum Installation

7. **Emergency Version (Planum 1500)** – Before sliding the fitting onto bracket. Insert the emergency Indicator LED into the grommet, push down until it locks in place.

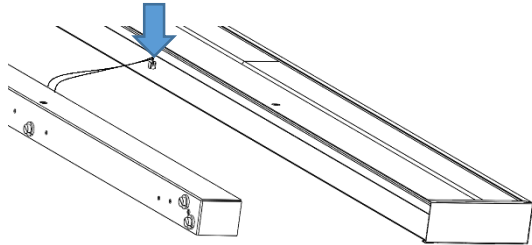

8.

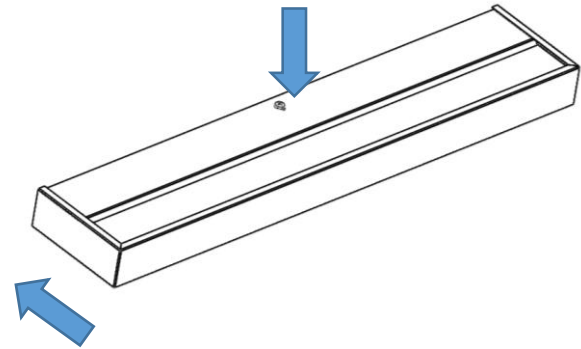

Ensure fitting is pushed flush to the wall before the fixing screw is tightened.

9.

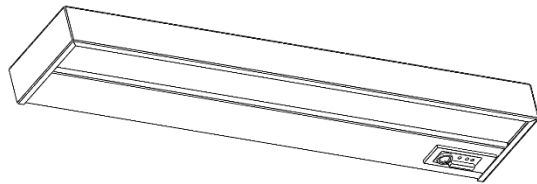

Installation is now complete.

10.

11.

12.

13.

14.