

## BTEC Secure Installation

230-240V / 50-60Hz  
IP65 (below ceiling)  
IK10

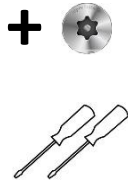

### WARNING - THIS LUMINAIRE MUST BE EARTHED

This luminaire has been tested and is manufactured to comply with BS EN 60598 : specification for general requirements and tests. It should be installed by a suitably qualified person in accordance with IEE.

**CAUTION:** there is a potential risk of electric shock from the LED boards when the product is operational with the cover removed.

**NOTE:** INSTALLATION AND OPERATION OF THE LUMINAIRE BEYOND ITS SCOPE OF SUPPLY WILL INVALIDATE THE WARRANTY.

DIL-0291-0002

### 1. Void clearance required.

#### Standard Fitting

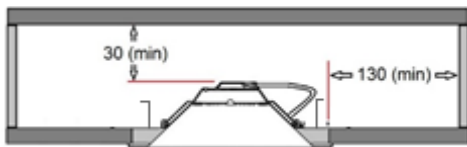

#### Emergency Fitting – due to emergency gear box

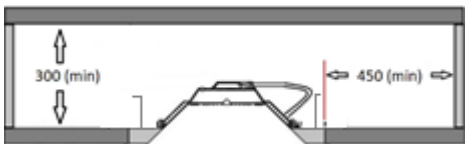

### 2.

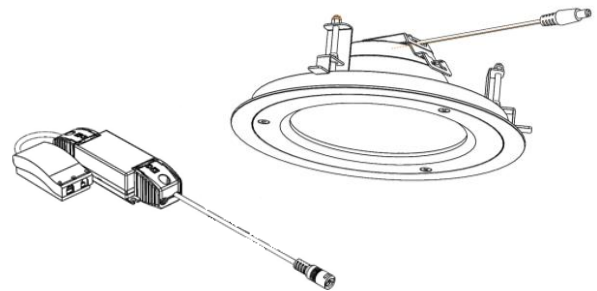

Cut-out (min) – 195mm

### 3.

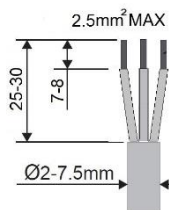
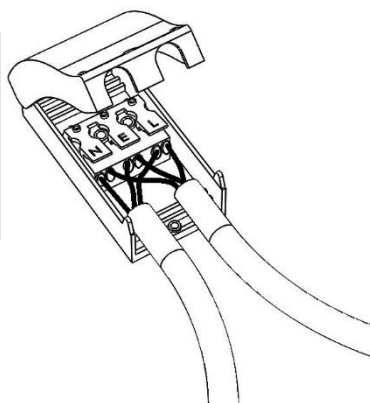
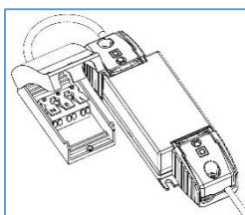

220-240V ~ 50/60Hz

### 4.

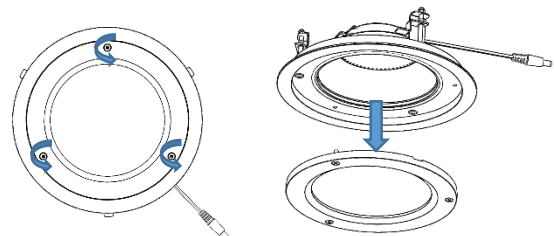

Remove front bezel and diffuser.

### 5.

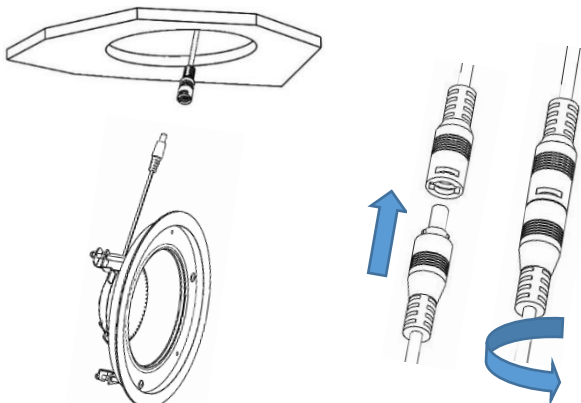

### 6.

Ensure all brackets are retracted and at maximum height before installation

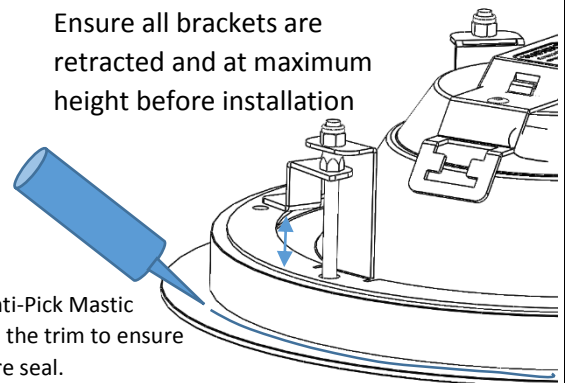

Run Anti-Pick Mastic behind the trim to ensure a secure seal.

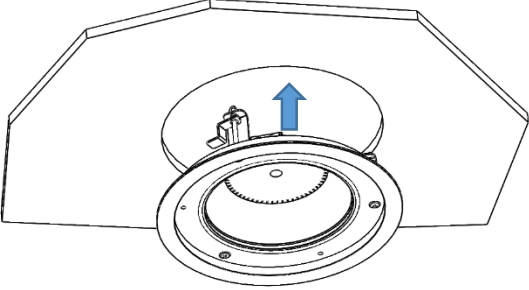
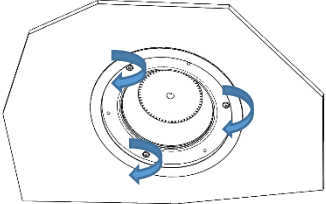
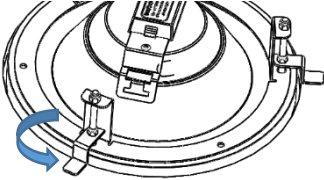
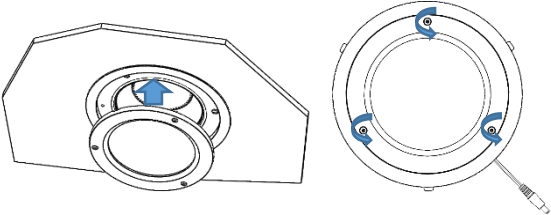
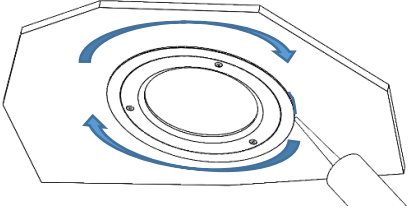
<p>7.</p> 	<p>8.</p> <p>Tighten the front 3 screws until the brackets engage on the back of the ceiling.</p>  <hr/>  <p>The brackets will swing out and engage on the back of the ceiling</p>
<p>9.</p>  <p>Re attach front bezel and diffuser and secure in place using the tamper resistant screws supplied.</p>	<p>10.</p>  <p>Run Anti-Pick Mastic around the profile of the fitting ensuring a water tight seal. Must be installed with anti pick mastic to meet ligature resistant requirements.</p>
<p>11.</p>	<p>12.</p>
<p>13.</p>	<p>14.</p>