

Rubix Surface Installation

220-240V / 50-60Hz
IP20



Terminal Labelling:

Power	
L1	Switched Live
E	Earth
N	Neutral
Emergency	
L2	Unswitched Live
DA/AT3	DALI Autotest
DA/AT3	DALI Autotest
Dimming	
-/D1/DA	Analogue/DSI/DALI
+/D2/DA	Analogue/DSI/DALI
L3	Switch Dim / Corridor Function

WARNING: Luminaire must be earthed. Risk of electric shock from LED boards if operated with cover removed. Installation / operation outside of luminaires intended scope invalidates warranty. Suitable only for domestic / light industrial / industrial applications within the scope of EN55015. Tested to compliance with BSEN 60598: specification for general requirements and tests. Must be installed by a suitably qualified person in accordance with all relevant legislation. Ambient operating temperature of 0°C to 25°C. If maximum operating temperature is exceeded luminaire will automatically dim / switch off. Terminal blocks are rated to 16A unless stated otherwise. The light source contained in this luminaire shall only be replaced by the manufacturer or his service agent or a similar qualified person.

LUMINAIRES WITH EMERGENCY PACK: When supply is isolated battery output terminals may be live if battery is connected. Isolate mains and battery before servicing. Emergency luminaires require unswitched live connection taken from same phase as switched supply. When unswitched supply is connected status indicator illuminates green, when unswitched supply is disconnected indicator extinguishes and luminaire operates in emergency mode. 24 hour charge period required before undertaking full discharge test. Emergency test sheets provided should be used to record all emergency tests. Batteries should be replaced when 3 hour duration is not met. Excessive switching of permanent live may result in premature battery failure. Battery electrolyte can be harmful to eyes / open wounds, do not puncture, if electrolyte touches skin / eyes flush with water. Do not incinerate batteries.

1.

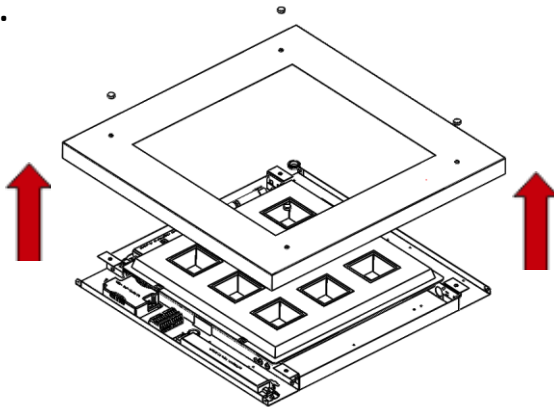

Remove screws and release frame from fitting.

2.

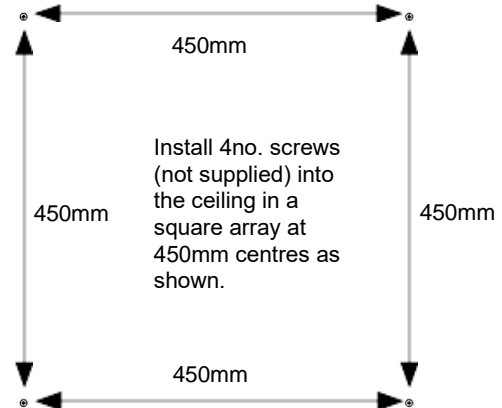

Install 4no. screws (not supplied) into the ceiling in a square array at 450mm centres as shown.

3.

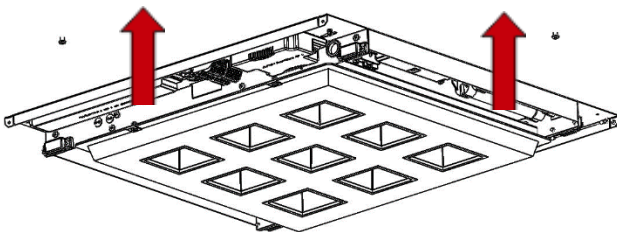

Lift fitting up onto the 4no. Screws. Four keyhole slots in the rear of the fitting should align with the screws.

4.

Slide fitting to one side along the keyhole slots as shown.

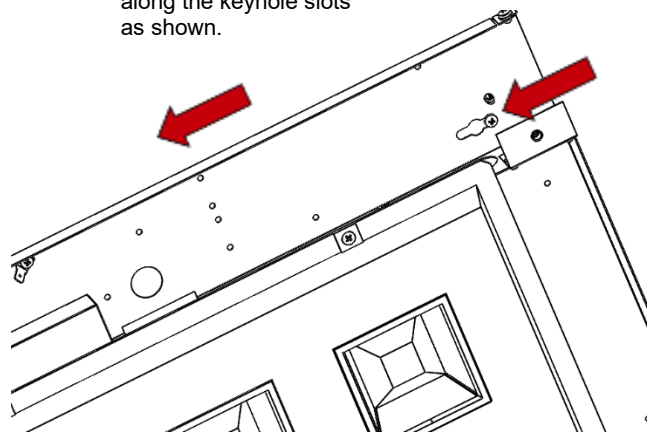

5.

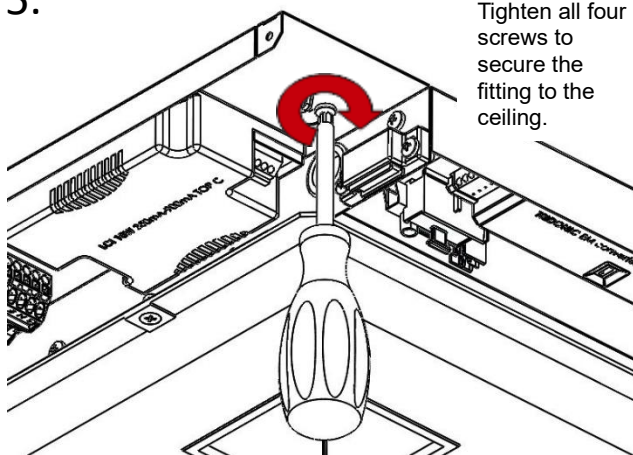

Tighten all four screws to secure the fitting to the ceiling.

6.

Feed mains cable(s) through grommet in tray and wire into marked terminals as required.

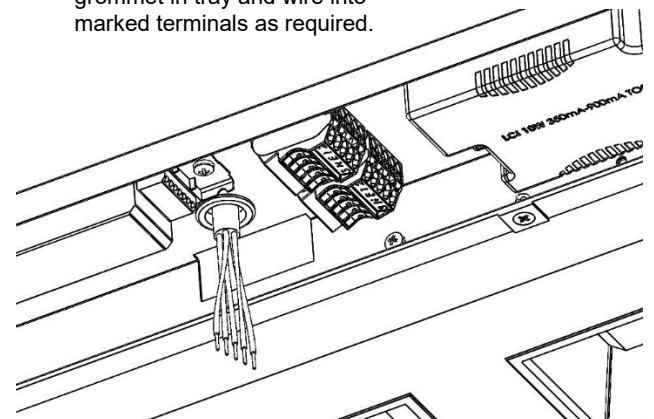

Rubix Surface Installation

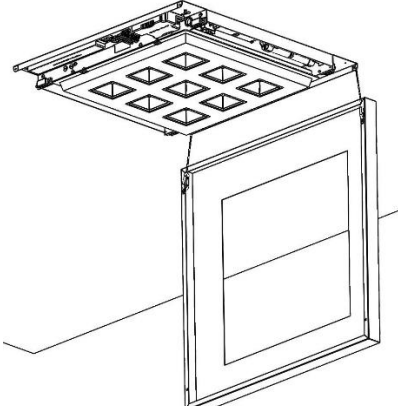
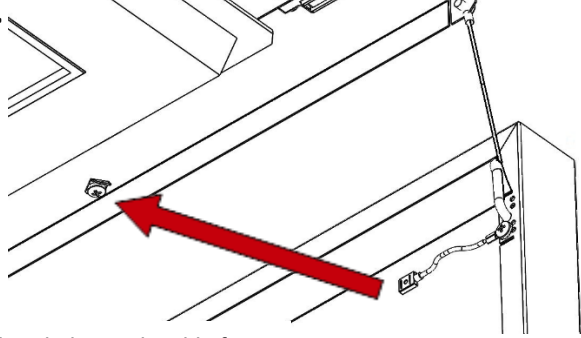
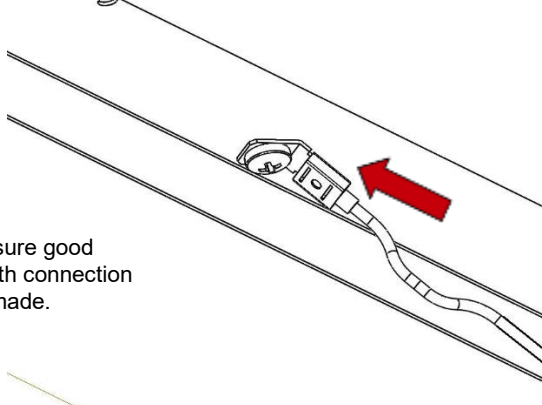
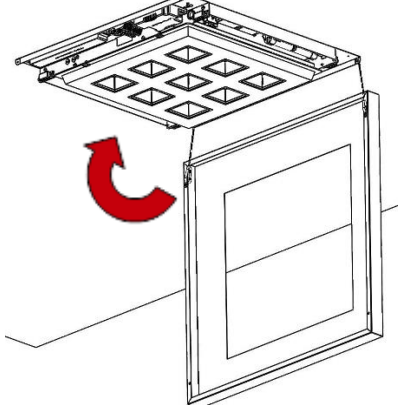
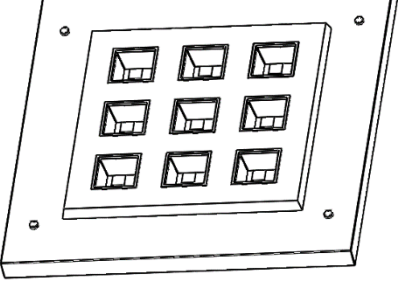
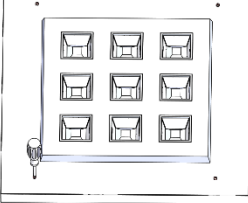
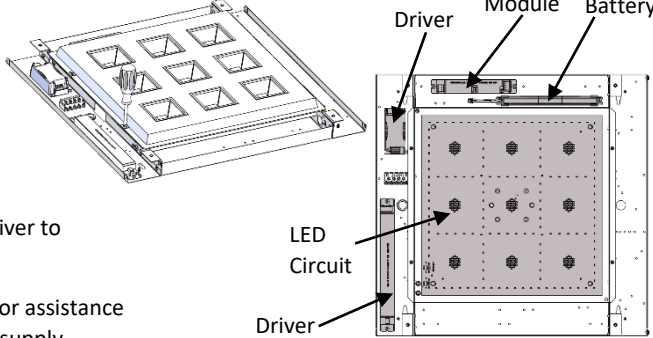
<p>7.</p>  <p>Attach the frame to the tethers and allow to hang as shown.</p>	<p>8.</p>  <p>Attach the earth cable from the frame to the tag shown on the main tray</p>
<p>9.</p>  <p>Ensure good earth connection is made.</p>	<p>10.</p>  <p>Lift frame up until flush and ensure there are no cables or tethers caught when doing so.</p>
<p>11.</p>  <p>Ensure the frame is sitting square and fasten all four screws, then close all cover caps</p>	<p>12.</p>
<p><u>Maintenance</u></p> <div style="display: flex; justify-content: space-between;"> <div style="width: 45%;"> <ol style="list-style-type: none"> ① Disconnect luminaire before undertaking maintenance or cleaning. ② Cleaning should be undertaken on external parts of the luminaire only using a slightly damp lint free cloth. ③ Remove frame using a pan pozi screwdriver to access components. ④ To replace LED Circuit use a pan pozi screwdriver to remove diffuser. </div> <div style="width: 45%;"> <ol style="list-style-type: none"> ⑤ Use a pan pozi screwdriver to remove components. ⑥ Please contact Dextra for assistance with spare component supply. </div> </div> <div style="display: flex; justify-content: space-around; align-items: center; margin-top: 10px;">   </div>	